



# **SPLIT TYPE AIR CONDITIONER INSTRUCTION MANUAL**



This instruction manual contains important information and recommendations that we would ask you to comply with to obtain best results from air conditioner.

Thank you once again.

# CONTENTS

---

SAFETY RULES AND RECOMMENDATIONS FOR THE INSTALLER.....	1
NAMES OF THE PARTS .....	4
INDOOR UNIT DISPLAY.....	5
EMERGENCY FUNCTION & AUTO-RESTART FUNCTION .....	6
REMOTE CONTROL .....	7
OPERATING INSTRUCTIONS .....	11
PROTECTION .....	17
INSTALLATION .....	18
MAINTENANCE .....	27
TROUBLESHOOTING .....	28

In line with the company's policy of continual product improvement, the aesthetic and dimensional characteristics, technical data and accessories of this appliance may be changed without notice.

# SAFETY RULES AND RECOMMENDATIONS FOR THE INSTALLER

- ⚠ Read this guide before installing and using the appliance.
- ⚠ During the installation of the indoor and outdoor units the access to the working area should be forbidden to children. Unforeseeable accidents could happen.
- ⚠ Make sure that the base of the outdoor unit is firmly fixed.
- ⚠ Check that air cannot enter the refrigerant system and check for refrigerant leaks when moving the air conditioner.
- ⚠ Carry out a test cycle after installing the air conditioner and record the operating data.
- ⚠ The ratings of the fuse installed in the built-in control unit are T 5A / 250V.
- ⚠ The user must protect the indoor unit with a fuse of suitable capacity for the maximum input current or with another overload protection device.
- ⚠ Ensure that the mains voltage corresponds to that stamped on the rating plate. Keep the switch or power plug clean. Insert the power plug correctly and firmly into the socket, thereby avoiding the risk of electric shock or fire due to insufficient contact.
- ⚠ Check that the socket is suitable for the plug, otherwise have the socket changed.
- ⚠ The appliance must be fitted with means for disconnection from the supply mains having a contact separation in all poles that provide full disconnection under overvoltage category III conditions, and these means must be incorporated in the fixed wiring in accordance with the wiring rules.
- ⚠ The air conditioner must be installed by professional or qualified persons.

- ⚠ Do not install the appliance at a distance of less than 20" from inflammable substances (alcohol, etc.) Or from pressurised containers (e.g. spray cans).
- ⚠ If the appliance is used in areas without the possibility of ventilation, precautions must be taken to prevent any leaks of refrigerant gas from remaining in the environment and creating a danger of fire.
- ⚠ The packaging materials are recyclable and should be disposed of in the separate waste bins. Take the air conditioner at the end of its life to an authorized waste collection center for disposal.
- ⚠ Only use the air conditioner as instructed in this booklet. These instructions are not intended to cover every possible condition and situation. As with any electrical household appliance, common sense and caution are therefore always recommended for installation, operation and maintenance.
- ⚠ The appliance must be installed in accordance with applicable national regulations.
- ⚠ Before accessing the terminals, all the power circuits must be disconnected from the power supply.
- ⚠ Installation must be performed in accordance with the requirements of NEC and CEC by authorized personnel only.
- ⚠ This appliance can be used by children aged from 8 years and above and persons with reduced physical, sensory or mental capabilities or lack of experience and knowledge if they have been given supervision or instruction concerning use of the appliance in a safe way and understand the hazards involved. Children shall not play with the appliance. Cleaning and user maintenance shall not be made by children without supervision.

## SAFETY RULES AND RECOMMENDATIONS FOR THE USER

- ⚠ Do not try to install the air condition alone; always contact specialized technical personnel.
- ⚠ Cleaning and maintenance must be carried out by specialised technical personnel. In any case disconnect the appliance from the mains electricity supply before carrying out any cleaning or maintenance.
- ⚠ Ensure that the mains voltage corresponds to that stamped on the rating plate. Keep the switch and power plug clean. Insert the power plug correctly and firmly into the socket, thereby avoiding the risk of electric shock or fire due to insufficient contact.
- ⚠ Do not pull out the plug to switch off the appliance when it is in operation, since this could create a spark and cause a fire, etc.
- ⚠ This appliance has been made for air conditioning domestic environments and must not be used for any other purpose, such as for drying clothes, cooling food, etc.
- ⚠ The packaging materials are recyclable and should be disposed of in separate waste bins. Take the air conditioner at the end of its life to an authorized waste collection center for disposal.
- ⚠ Always use the appliance with the air filter mounted. The use of the air conditioner without air filter could cause an excessive accumulation of dust or waste on the inner parts of the device with possible subsequent failures.
- ⚠ The user is responsible for having the appliance installed by a qualified technician, who must check that it is earthed in accordance with current legislation and insert a thermomagnetic circuit breaker.
- ⚠ The batteries in the remote control must be recycled or disposed of properly. Disposal of Scrap Batteries - Please discard the batteries as sorted municipal waste at the accessible collection point.
- ⚠ Never remain directly exposed to the flow of cold air for a long time. The direct and prolonged exposition to cold air could be dangerous for your health. Particular care should be taken in the rooms where there are children, old or sick people.
- ⚠ If the appliance gives off smoke or there is a smell of burning, immediately cut off the power supply and contact an authorized service center.
- ⚠ The prolonged use of the device in such conditions could cause fire or electrocution.
- ⚠ Have repairs carried out only by an authorized Service Center. Incorrect repair could expose the user to the risk of electric shock, etc.
- ⚠ Unhook the automatic switch if you foresee not using the device for a long time. The airflow direction must be properly adjusted.
- ⚠ The flaps must be directed downwards in the heating mode and upwards in the cooling mode.
- ⚠ Only use the air conditioner as instructed in this booklet. These instructions are not intended to cover every possible condition and situation. As with any electrical household appliance, common sense and caution are therefore always recommended for installation, operation and maintenance.
- ⚠ Ensure that the appliance is disconnected from the power supply when it will remain inoperative for a long period and before carrying out any cleaning or maintenance.
- ⚠ Selecting the most suitable temperature can prevent damage to the appliance.

## SAFETY RULES AND PROHIBITIONS

- ⊖ Do not bend, tug or compress the power cord since this could damage it. Electrical shocks or fire are caused by a damaged power cord. Specialized technical personnel only must replace a damaged power cord.
- ⊖ Do not use extensions or gang modules.
- ⊖ Do not touch the appliance when barefoot or parts of the body are wet or damp.
- ⊖ Do not obstruct the air inlet or outlet of the indoor or the outdoor unit.  
The obstruction of these openings causes a reduction in the operative efficiency of the air conditioner with possible consequent failures or damages.
- ⊖ In no way alter the characteristics of the appliance.
- ⊖ Do not install the appliance in environments where the air could contain gas, oil or sulphur or near sources of heat.
- ⊖ This appliance is not intended for use by persons (including children) with reduced physical, sensory or mental capabilities, or lack of experience and knowledge, unless they have been given supervision or instruction concerning use of the appliance by a person responsible for their safety.
- ⊖ Do not climb onto or place any heavy or hot objects on top of the appliance.
- ⊖ Do not leave windows or doors open when the air conditioner is operating.
- ⊖ Do not direct the airflow onto plants or animals.
- ⊖ A long direct exposition to the flow of cold air of the conditioner could have negative effects on plants and animals.
- ⊖ Do not put the conditioner in contact with water.  
The electrical insulation could be damaged and thus causing electrocution.
- ⊖ Do not climb onto or place any objects on the outdoor unit
- ⊖ Never insert your finger, a stick, etc. into the air inlet / outlet. Doing so could cause injury.
- ⊖ Children should be supervised to ensure that they do not play with the appliance. If the supply cord is damaged, it must be replaced by the manufacturer, its service agent or similarly qualified persons in order to avoid a hazard.

# NAMES OF THE PARTS

## INDOOR UNIT

No.	Description
1	Front panel
2	Air filter
3	Optional filter (if installed)
4	LED Display
5	Signal receiver
6	Terminal block cover
7	Ionizer generator(if installed)
8	Deflectors
9	Emergency button
10	Indoor unit rating label (Stick position optional)
11	Airflow direction flaps
12	Remote control

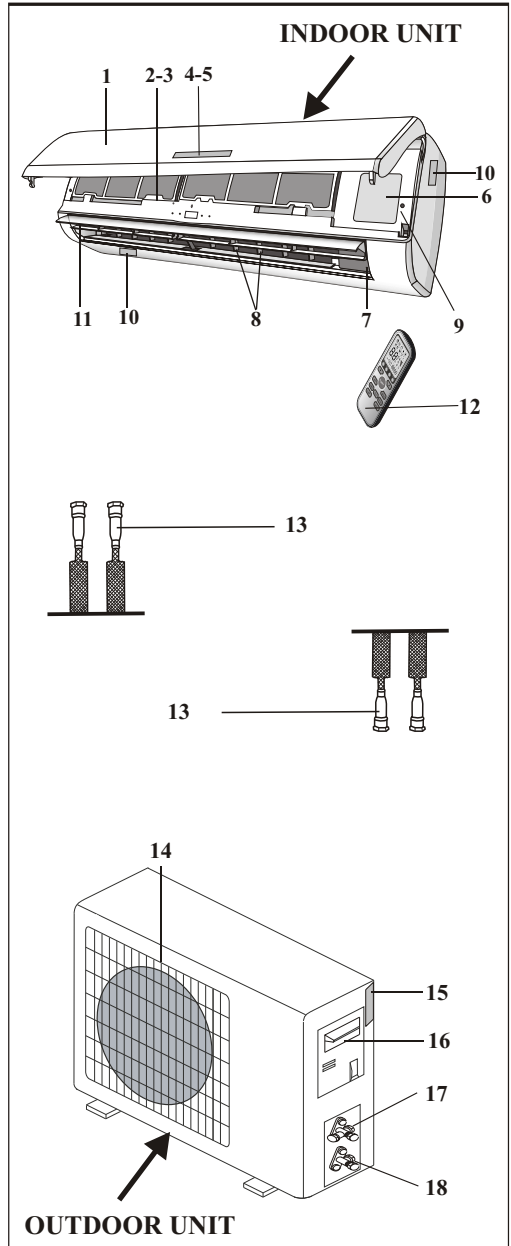

## OUTDOOR UNIT

No.	Description
13	Pipe connections (optional)

## OUTDOOR UNIT

No.	Description
14	Air outlet grille
15	Outdoor unit rating label
16	Cover
17	gas valve
18	liquid valve

### WALL AIR-CONDITIONER

- The air conditioner is made up of two or more units connected between themselves through copper pipes (properly insulated) and an electrical connecting cable.
- The indoor unit is installed on the walls of the room to be conditioned.
- The outdoor unit is installed on the floor or on the wall on suitable brackets.
- Technical data of the air conditioner are printed on the labels placed on the indoor and outdoor units.
- The remote control has been designed for easy and fast use.

## OUTDOOR UNIT

*Note: the above figures are only intended to be a simple diagram of the appliance and may not correspond to the appearance of the units that have been purchased.*

# INDOOR UNIT DISPLAY

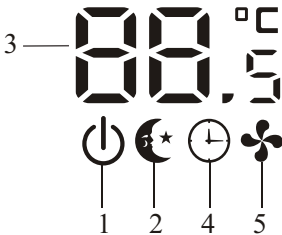
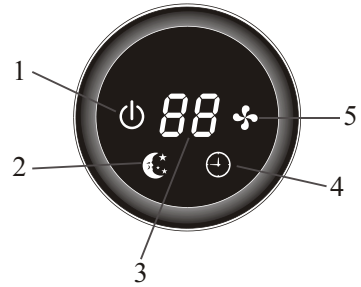
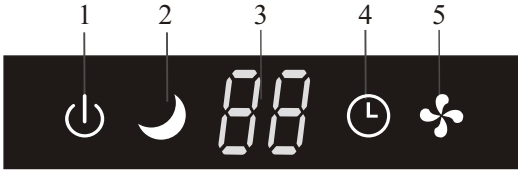
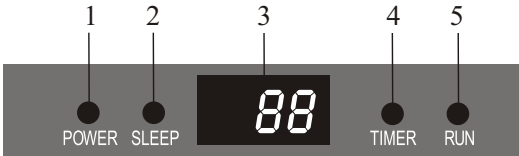

No.	Led		Function
1	POWER	⏻	This symbol appears when the unit is power on
2	SLEEP	☾	SLEEP mode
3	Temperature display (if present) /Error code	88	(1) Lights up during Timer operation when the air conditioner is operational (2)Displays the malfunction code when fault occurs.
4	TIMER	⌚	Lights up during Timer operation.
5	RUN	⚙️	The symbol appears when the unit is turned on, and disappear when the unit is turned off.

⚠️ *The shape and position of switches and indicators may be different according to the model, but their function is the same.*

*According to the model, it may only show 2 numbers on the indoor display though there are 3 numbers on display of the remote controller .(Example: it is 28.5 on the display of the remote controller but 28 on the indoor display )*

# EMERGENCY FUNCTION & AUTO-RESTART FUNCTION

## EMERGENCY FUNCTION

If the remote controller fails to work or maintenance necessary, proceed as following:

Open and lift the front panel up to an angle to reach the emergency button.

Press the emergency button, the unit will operate COOL mode at first. Press again within 3 seconds, the unit will change to HEAT mode. Press again after 5 seconds, the unit will turn off.

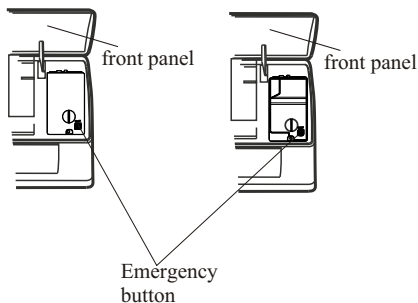

The emergency button is located on the right end of the unit under the front panel.





## AUTO-RESTART FUNCTION

The appliance is preset with an auto-restart function. In case of a sudden power failure, the module will memorizes the setting conditions before the power failure. When the power restores, the unit will restart automatically with the previous settings preserved by the memory function.





 *The shape and position of the emergency button may be different according to the model, but their function is the same.*



# REMOTE CONTROL ( NOTE: SEE ILLUSTRATION ON PAGE 8 )

No.	Button	Function
1		To turn on or off the air conditioner .
2	OPTION	To activate or deactivate optional function(Check below table).
3	∨	To decrease temperature, time setting or choose the function.
4	∧	To increase temperature, time setting or choose the function.
5	ECO	Press this button to activate/deactivate the ECO function .
6	TURBO	Press this button to activate/deactivate the Super function which enables the unit to reach the preset temperature in the shortest time.
7	MODE	To select the mode of operation(AUTO COOL DRY FAN HEAT).
8	FAN	To select the fan speed of auto/mute/low/mid-low/mid/mid-high/high/ turbo, cycle as below. 
9		To activate the swing of horizontal flap(up/down) or deactivate it.
10		To activate the swing of vertical flap(left/right) or deactivate it.

Celsius or Fahrenheit degree change: Long press “TURBO” button of remote controller, for more than 6 seconds, until the temperature display changes to Celsius or Fahrenheit.

ON/OFF	Mode	OPTIONS
ON	AUTO	TIMER DISPLAY HEALTH I FEEL 8°C H
	COOL	TIMER DISPLAY HEALTH SLEEP MILDEW I FEEL 8°C H 
	DRY	TIMER DISPLAY HEALTH MILDEW I FEEL 8°C H
	FAN	TIMER DISPLAY HEALTH I FEEL 8°C H
	HEAT	TIMER DISPLAY HEALTH SLEEP I FEEL 8°C H 
OFF	AUTO	CLEAN TIMER DISPLAY HEALTH I FEEL 8°C H
	COOL	CLEAN TIMER DISPLAY HEALTH SLEEP MILDEW I FEEL 8°C H 
	DRY	CLEAN TIMER DISPLAY HEALTH MILDEW I FEEL 8°C H
	FAN	CLEAN TIMER DISPLAY HEALTH I FEEL 8°C H
	HEAT	CLEAN TIMER DISPLAY HEALTH SLEEP I FEEL 8°C H 

 You will hear a beep when you press the following buttons or select the following optional functions.



(Optional Function: COMFORTABLE COOLING airflow)

HEALTH (Optional Function: generate the ionizer)



(Optional Function: COMFORTABLE HEATING airflow)



(button: SWING LEFT/RIGHT)



(Optional Function: 8°C Heating)



(Optional Function: Wide-angle air supply)

# REMOTE CONTROL



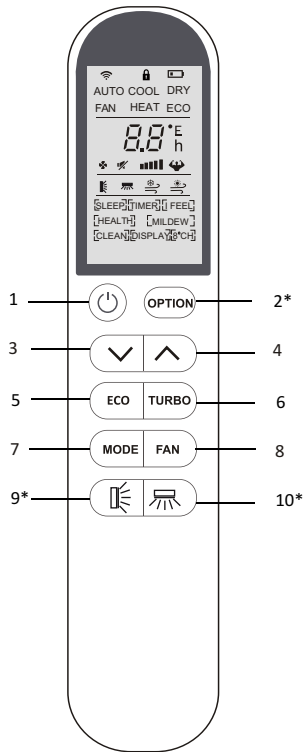







- ⚠ The display and some functions of the remote control may vary according to the model.
- ⚠ The shape and position of buttons and indicators may vary according to the model, but their function is the same.
- ⚠ The unit confirms the correct reception of each button with a beep.

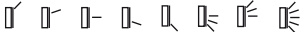

# REMOTE CONTROL

## Remote control DISPLAY

### Meaning of symbols on the liquid crystal display

No.	Symbols	Meaning
1		Single indicator
2		Child Lock function indicator
3		Battery indicator
4	AUTO	Mode Auto function indicator
5	COOL	Mode Cooling indicator
6	DRY	Mode Dry indicator
7	FAN	Mode Fan indicator
8	HEAT	Mode Heating indicator
9	ECO	ECO indicator
10	23h [TIMER]	Timer indicator
11	88°F	Temperature indicator
12		Fan speed indicator: Auto/low/mid-low/mid/mid-high/high
13		Mute indicator
14		SUPER indicator
15		Flap swing angle indicator
16		Deflector swing angle indicator
17		Comfortable cooling airflow indicator
18		Comfortable heating airflow indicator
19	[SLEEP] [TIMER] [FEEL] [HEALTH] [MILDEW] [CLEAN] [DISPLAY] [8°C]	Optional functions indicator

 You will hear a beep when you press the following buttons or select the following optional functions.

 (Optional Function: COMFORTABLE COOLING airflow)

 (Optional Function: COMFORTABLE HEATING airflow)

 (Optional Function: 8°C Heating)

**HEALTH** (Optional Function: generate the ionizer)

 (button: SWING LEFT/RIGHT)

 (Optional Function: Wide-angle air supply)

# REMOTE CONTROL

## Replacement of Batteries

Remove the battery cover plate from the rear of the remote control, by sliding it in the direction of the arrow. Install the batteries according the direction (+ and -) shown on the Remote Control. Reinstall the battery cover by sliding it into place.

- ⚠ Use 2 LRO 3 AAA (1.5V) batteries. Do not use rechargeable batteries.  
Replace the old batteries with new ones of the same type when the display is no longer legible.  
Do not dispose batteries as unsorted municipal waste.  
Collection of such waste separately for special treatment is necessary.

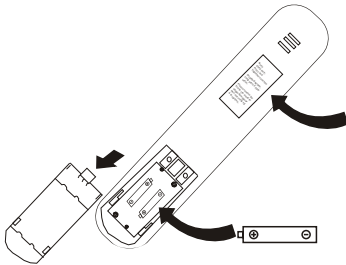

Note  
Child-lock: Press  $\vee$  and  $\wedge$  together to active.

Display ON/OFF:  
Long press ECO button.

Please remove batteries to avoid leakage damage when not using for a long time.

- ⚠ Each time when you insert the batteries for the first 3 minutes, turn off the remote control, then you can program it for (only cooling) or (cooling and heating) type.
1. Press and hold MODE button over (5seconds) to access the change mode to COOL or HEAT;
  2. Press and hold the MODE button, until it switch to COOL or HEAT;
  3. Then release the pressing and wait for 5 seconds, the function will be selected.

NOTE: If you adjust the remote control in cooling mode, it will not be possible to activate the heating function in units with a heating pump. If you need to reset, take out the batteries and install again.

- ⚠ You also can program the temperature display switch over function between  $^{\circ}\text{C}$  and  $^{\circ}\text{F}$ .
1. Press and hold the TURBO button over (5seconds) to get into the change mode;
  2. Press and hold the TURBO button, until it switch to  $^{\circ}\text{C}$  and  $^{\circ}\text{F}$ ;
  3. Then release the pressing and wait for 5 seconds, the function will be selected.

- ⚠
1. Direct the remote control toward the Air conditioner.
  2. Check that there are no objects between the remote control and the Signal receptor in the indoor unit.
  3. Never leave the remote control exposed to the rays of the sun.
  4. Keep the remote control at a distance of at least 1m from the television or other electrical appliances.

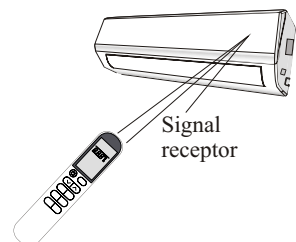





# OPERATING INSTRUCTIONS

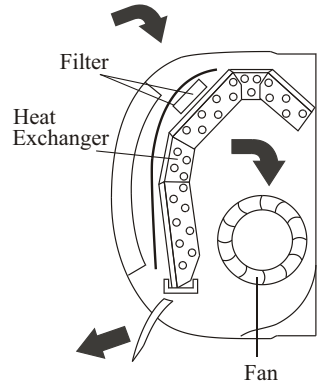



The air sucked by the fan enters from the grill and passes through the filter, then it is cooled/dehumidified or heated through the heat exchanger.

The direction of the air outlet is motorized up and down by flaps, and manually moved right and left by the vertical deflectors, for some models, the vertical deflectors could be controlled by motor as well.















## “SWING” CONTROL OF THE AIR FLOW

1. Press the button  to activate the “FLAP”,  
 (1) If press time interval is within 2 seconds, the swing will cycle as below:  →  →  → deactivate

(2) If press time is longer, the swing angle range of horizontal flap will cycle as below:  →  →  →  → 

(3) If press time interval is over 2 seconds, it will be deactivate the air flow is directed alternatively from up to down, to guarantee an even distribution of the air in the room.



2. Press the button  to activate the motorized “deflectors”,  
 (1) If press time interval is within 2 seconds, the swing will cycle as below:  →  →  →  →  →  → deactivate

(2) If press time is longer, the swing will cycle as below:  →  →  →  → 

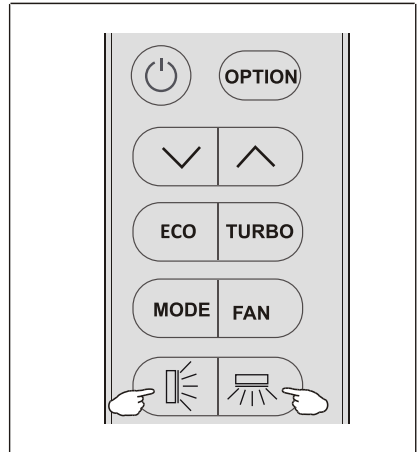
(3) If press time interval is over 2 seconds, it will deactivate the air flow is directed alternatively from left to right. (Optional function, depends on the model)



The deflectors are positioned manually and placed under the flaps. They allow to direct the air flow rightward or leftward.

-  This adjustment must be done while the appliance is switched off.
-  Never position “Flaps” manually, the delicate mechanism might seriously damaged!
-  Never poke fingers, sticks or other objects in the air inlet or outlet vents. Such accidental contact with live parts might cause unforeseeable damage or injury.

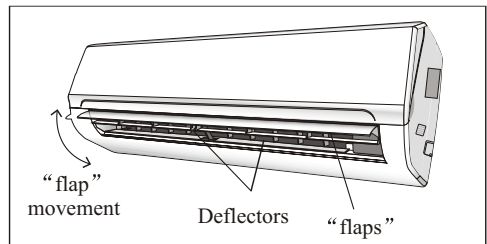

# OPERATING INSTRUCTIONS

## COOLING MODE

### COOL

The cooling function allows the air conditioner to cool the room and at the same time reduces Air humidity.

To activate the cooling function ( COOL ), press the **MODE** button until the symbol COOL appears on the display.

The cooling function is activated by setting the button  $\nabla$  or  $\blacktriangle$  at a temperature lower than that of the room.

To optimize the function of the Air conditioner, adjust the temperature ( 1 ), the speed ( 2 ) and the direction of the air flow ( 3 ) by pressing the button indicated.

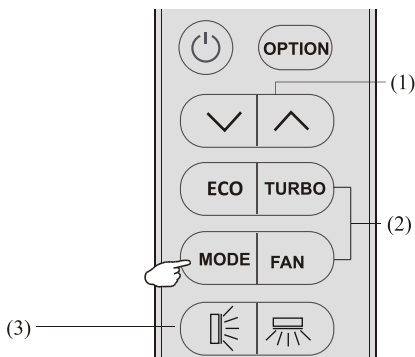

## HEATING MODE

### HEAT

The heating function allows the air conditioner to heat the room.

To activate the heating function ( HEAT ), press the **MODE** button until the symbol HEAT appears on the display.

With the button  $\nabla$  or  $\blacktriangle$  set a temperature higher than that of the room.

To optimize the function of the Air conditioner adjust the temperature ( 1 ), the speed ( 2 ) and the direction of the air flow ( 3 ) by pressing the button indicated.



In HEATING operation, the appliance can automatically activate a defrost cycle, which is essential to clean the frost on the condenser so as to recover its heat exchange function. This procedure usually lasts for 2-10 minutes during defrosting, indoor unit fan stop operation. After defrosting, it resumes to HEATING mode automatically.

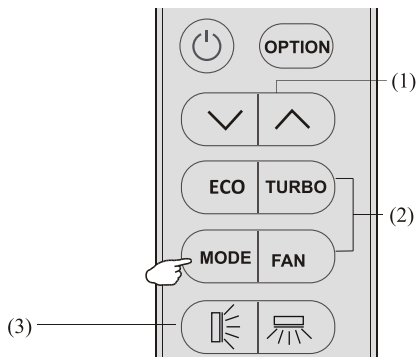

## DRY MODE

### DRY

This function reduces the humidity of the air to make the room more comfortable.

To set the DRY mode, Press **MODE** until DRY appears in the display. An automatic function of alternating cooling cycles and air fan is activated.

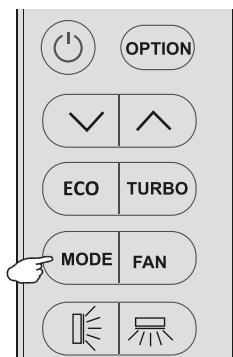

# OPERATING INSTRUCTIONS

## FAN MODE(Not FAN button)

**FAN**

Fan mode ventilation only.

To set the FAN mode, Press **[MODE]** until FAN appears on the display.

To optimize the function of the air conditioner, adjust the temperature(1), the speed (2) and the direction of the air flow (3) by pressing the buttons indicated.

## AUTO MODE

**AUTO**

Automatic mode.

To activate the AUTO mode of operation, press the **[MODE]** button on the remote control until the symbol AUTO appears on the display.

In AUTO mode the run mode will be set automatically according to the room temperature.

To optimize the function of the air conditioner, adjust the temperature(1), the speed (2) and the direction of the air flow (3) by pressing the buttons indicated.

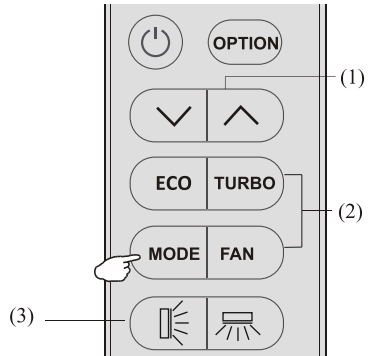

## DISPLAY function (Indoor display)

**[DISPLAY]**

Switch ON/OFF the LED display on panel

Press **[OPTION]** button, select the **[DISPLAY]** by pressing the button ^ or v until symbol **[DISPLAY]** is flashing; Press **[OPTION]** again to switch off the LED display on the panel, and **[DISPLAY]** appears on the remote control display. Do it again to switch on the LED display.

## SLEEP function

**[SLEEP]**

Press **[OPTION]** button, select the **[SLEEP]** by pressing the button ^ or v until symbol **[SLEEP]** is flashing; Press **[OPTION]** again to activate the **[SLEEP]** function, and **[SLEEP]** appears on the display. Do it again to deactivate this function.

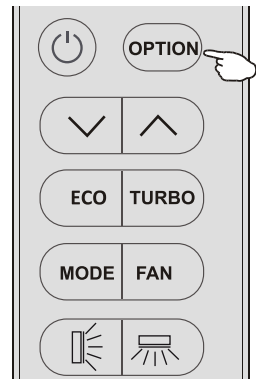

After 10 hours running in sleep mode, the air conditioner will change to the previous setting mode.

# OPERATING INSTRUCTIONS

## ECO function

### ECO

In this mode the appliance automatically sets the operation to achieve energy savings.

1. Press the "ON / OFF" button to turn on appliance and select a COOLING / HEATING mode.
2. Press the "ECO" button, the appliance will run in ECO mode.
3. Pressing the "ECO" button again will cancel the mode, "ECO" will no longer be shown on the LCD screen.

#### NOTE:

The ECO function is available in COOLING and HEATING modes.

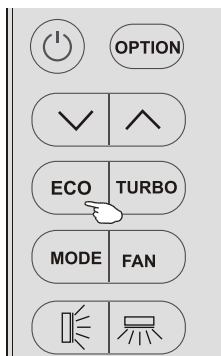

## Turbo function



To activate turbo function, press the TURBO button or press the FAN button until symbol  appears on the display.

To cancel this function, press the FAN to switch other fan speed or press the TURBO button again.

In AUTO/HEAT/COOL/FAN mode, when you select TURBO feature, it will use the highest fan setting to blow strong airflow.

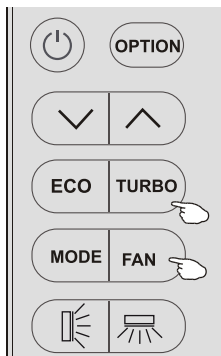



# OPERATING INSTRUCTIONS

## TIMER function



To set the automatic timer switch-on /off of the air conditioner

Timer setting/change/cancel:

1. Press **OPTION** button, select the Timer by pressing the button  $\wedge$  or  $\vee$  until symbol **TIMER** is flashing;
2. Press **OPTION** again, the data symbol like **5.5 h** and **TIMER** will be flashing;
3. To set the timer or change the timer:
  - (1) Press the button  $\wedge$  or  $\vee$  to set the expected timer (Increase or decrease at half-hour intervals) the symbols **h** and **TIMER** both are flashing.
  - (2) Press **OPTION** or wait for 5 seconds without any operation to confirm the timer, the pre-setting timer like **5.5 h** and symbol **TIMER** will be on the display.
4. To cancel the timer(if **TIMER** is on). Repeat step 1, step 2, then press **OPTION** or wait for 5 seconds without any operation to cancel the timer.

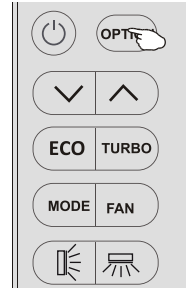

A sample for the Timer-on as Figure1, Timer-off as Figure2

Note:

All programming should be operated within 5 seconds, otherwise the setting will be cancelled.

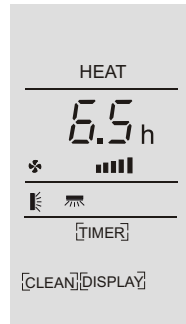

Figure1,Timer-on when switch off

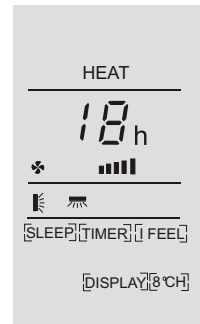

Figure2,Timer-off when switch on

## I FEEL function (Optional)



Press **OPTION** button, select the I FEEL by pressing the button  $\wedge$  or  $\vee$  until symbol I FEEL is flashing; Press **OPTION** again to activate the I FEEL function, and **I FEEL** will appear on the display. Do it again to deactivate this function.

This function enables the remote control to measure the temperature at its current location, and send this signal to the air conditioner to optimize the temperature around you and ensure the comfort.

It will automatically deactivate 2 hours later.

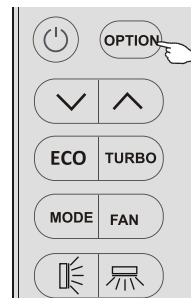

# OPERATING INSTRUCTIONS

## MILDEW function (Optional)

[MILDEW]

Press [OPTION] button, select the [MILDEW] by pressing the button ^ or v until symbol [MILDEW] is flashing; Press [OPTION] again to activate the [MILDEW] function, [MILDEW] will appear on the display. Do it again to deactivate this function.

After running COOL/DRY for more than 30 minutes, you can operate this function, the unit will blow airflow for about 15 minutes to dry the inner parts to avoid mildew, then shuts off the unit.

*Note: MILDEW function only available in DRY/COOLING mode.*

## SELF-CLEAN function (Optional)

[CLEAN]

Switch off the air conditioner at first.

Press [OPTION] button, select CLEAN by pressing the button ^ or v until symbol CLEAN is flashing; Press [OPTION] again to activate the CLEAN function, and [CLEAN] appears on the display. Do it again to deactivate this function.

1. This function helps carry away the accumulated dirt, bacteria, etc from the evaporator.
2. This function will run about 30 minutes, and it will return to the pre-setting mode. You can press  to cancel this function during the process. You will hear 2 beeps when it's finished or cancelled.
3. It's normal if there is some noise during this function process, as plastic materials expand with heat and contract with cold.
4. We suggest operating this function at the following ambient conditions to avoid certain safety protection features.

Indoor unit	Temp < 86°F (30°C)
Outdoor unit	41°F (5°C) < Temp < 86°F (30°C)

5. It's suggested to utilize this function every 3 months.

## 8°C heating function (Optional)

[8°C H]

It can be set in Cool/Heat/Dry/Fan/Auto mode, but you need to turn off the unit to activate it.

1. Press [OPTION] at the first time, select the [8°C H] by pressing the button ^ or v until symbol [8°C H] is flashing; Press [OPTION] again to choose the 8°C heating function, and [8°C H] appears on the display. Do it again or change the mode to deactivate this function.
2. If the unit is standby, this function will automatically start heating mode when the indoor temperature is equal or lower than 8°C (46°F), it will return standby if the temperature is equal or higher than 18°C (64°F).

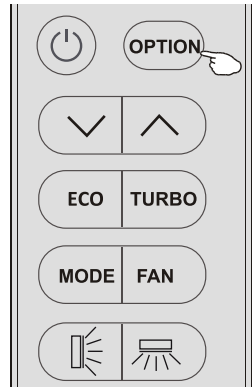

# PROTECTION

The protective device may trip and stop the appliance in the cases listed below.

## For T1 Climate condition models:

No.	MODEL	
1	Heating	Outdoor air temperature is over 86°F (30°C)
		Outdoor air temperature is below -13°F (-25°C)
		Room temperature is over 86°F (30°C)
2	Cooling	Outdoor air temperature is over 122°F (50°C)
		Outdoor air temperature is below 5°F (-15°C)

 *After stopping and restarting the air conditioner or after changing the mode during operation, the system does not restart immediately, Until after 3 minutes(Protection function for the compressor).*

# INSTALLATION---Selecting the Installation Place

## INDOOR UNIT

- Install the indoor unit level on a strong wall that is not subject to vibrations.
- The inlet and outlet ports should not be obstructed: the air should be able to blow all over the room.
- Do not install the unit near a source of heat, steam, or flammable gas.
- Install the unit near an electric socket or private circuit.
- Do not install the unit where it will be exposed to direct sunlight.
- Install the unit where connection between indoor and outdoor unit is as easy as possible.
- Install the unit where it is easy to drain the condensed water.
- Check the machine operation regularly and leave the necessary space (as shown in the picture).
- Install the indoor unit where the filter can be easily accessible.

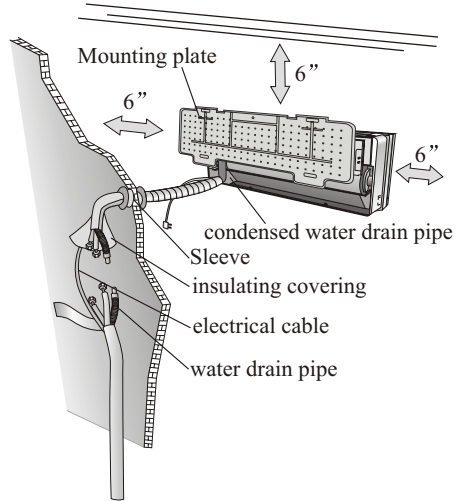

Minimum space to be left showing in the picture

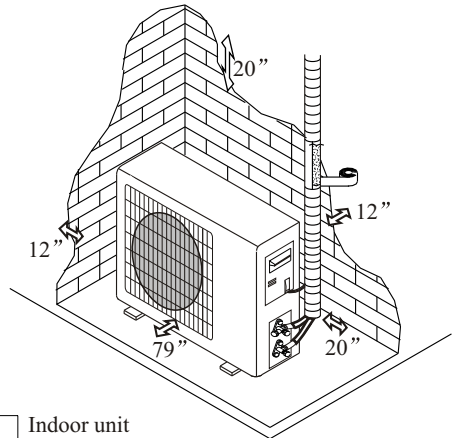

## OUTDOOR UNIT

- Do not install the outdoor unit near sources of heat, steam or flammable gas.
- Do not install the unit in too windy or dusty places.
- Do not install the unit where people often pass. Select a place where the air discharge and operating sound level will not disturb neighbours.
- Avoid installing the unit where it will be exposed to direct sunlight (other wise use a protection, if necessary, that should not interfere with the air flow).
- Leave space as shown in the picture for the air to circulate freely.
- Install the outdoor unit in a safe and solid place.
- If the outdoor unit is subject to vibration, place rubber gaskets onto the feet of the unit.

### Installation Diagram

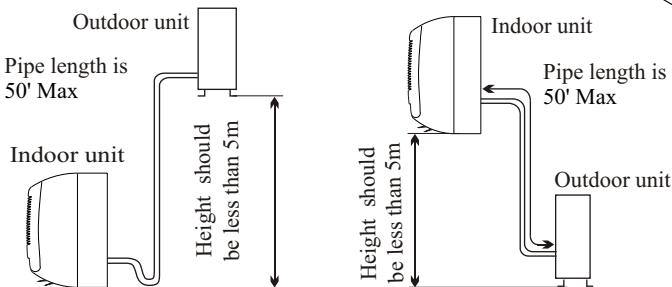

Only persons and/or companies qualified and experienced in the installation, service and repair of refrigerant products should be permitted to do so. The purchaser must ensure that the person and/or company who is to install, service or repair this air conditioner has qualifications and experience in refrigerant products.

# INSTALLATION MANUAL---Installation of the Indoor unit

Before starting installation, decide on the position of the indoor and outdoor units, taking into account the minimum space required around the units.

- ⚠ Install the indoor unit in the room to be air conditioned avoiding in corridors or communal areas.
- ⚠ Install the indoor unit at a height of at least 8 ft from the ground.

To install, proceed as follows:

## Installation of the mounting plate

1. By using a level, put the mounting plate in a perfect square position vertically and horizontally.
2. Drill 32 mm deep holes in the wall to fix the plate;
3. Insert the plastic anchors into the hole;
4. Fix the mounting plate by using the provided tapping screws;
5. Check that the mounting plate is correctly fixed;

*Note : The shape of the mounting plate may be different from the one above, but installation method is similar .*

## Drilling a hole in the wall for the piping

1. Decide where to drill the hole in the wall for the piping ( if necessary ) according to the position of the mounting plate;
2. Install a flexible flange through the hole in the wall to keep the latter intact and clean.

- ⚠ The hole must slope downwards towards the exterior.

*Note : Keep the drain pipe down towards the direction of the wall hole, otherwise leakage may occur.*

## Electrical connections---Indoor unit

1. Lift the front panel.
2. Take off the cover as indicated in the picture ( by removing a screw or by breaking the hooks).
3. For the electrical connections, see the circuit diagram on the right part of the unit under the front panel.
4. Connect the cable wires to the screw terminals by following the numbering. Use wire size suitable to the electric power input (see name plate on the unit) and according to all current national safety code requirements.
5. The cable connecting the outdoor and indoor units must be suitable for outdoor use.
6. The plug must be accessible also after the appliance has been installed so that it can be pulled out if necessary.
7. An efficient earth connection must be ensured.
8. If the power cable is damaged, it must be replaced by an authorised Service Centre.

*Note: The cable wires has been connected to the main PCB of indoor unit by manufacturer according to the model without terminal block.*

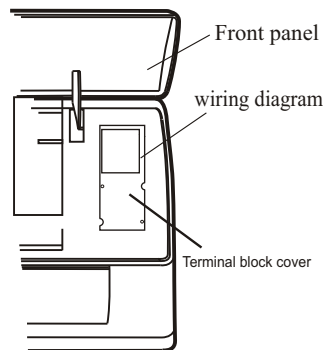
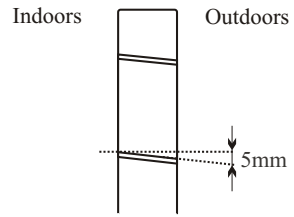
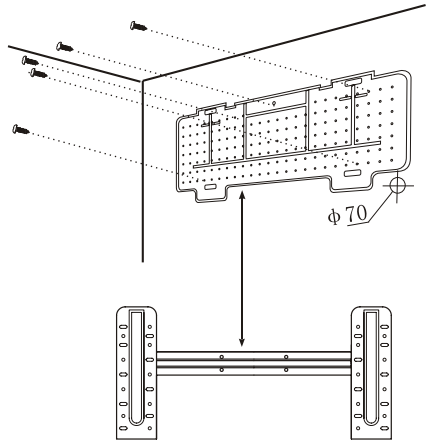

# INSTALLATION MANUAL---Installation of the Indoor unit

## Refrigerant piping connection

The piping can be ran in 3 directions (indicated by numbers in the pictures). When the piping is ran in direction 1 or 3, cut a notch along the groove on the side of the indoor unit with a cutter.

Run the piping in the direction of the wall hole and bind the copper pipes, the drain pipe and the power cables together with the tape with the drain pipe at the bottom, so that water can flow freely.

- Do not remove the cap from the pipe until connecting it, to avoid dampness or dirt from entering.
- If the pipe is bent or pulled too often, it will become stiff. Do not bend the pipe more than three times at one point.
- When extending the rolled pipe, straighten the pipe by unwinding it gently as shown in the picture.

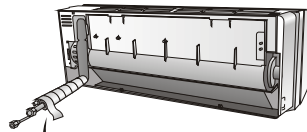
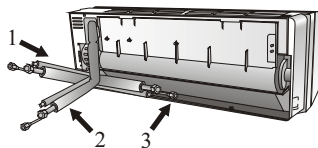

Shape the connection pipe

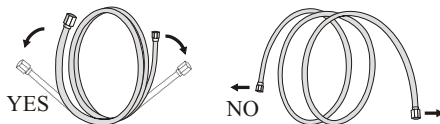

Extending the rolled pipe

## Connections to the indoor unit

1. Remove the indoor unit pipe cap (check that there is no debris inside).
2. Insert the flare nut and create a flange at the extreme end of the connection pipe.
3. Tighten the connections by using two wrenches working in opposite directions.

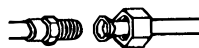

## Indoor unit condensed water drainage

The indoor unit condensed water drainage is fundamental for the success of the installation.

1. Place the drain hose below the piping, taking care not to create siphons.
2. The drain hose must slant downwards to aid drainage.
3. Do not bend the drain hose or leave it protruding or twisted and do not put the end of it in water. If an extension is connected to the drain hose, ensure that it is lagged when it passes into the indoor unit.
4. If the piping is installed to the right, the pipes, power cable and drain hose must be lagged and secured onto the rear of the unit with a pipe connection.
  - A) Insert the pipe connection into the relative slot.
  - B) Press to join the pipe connection to the base.

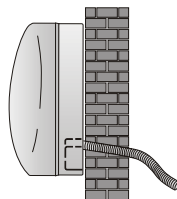

YES

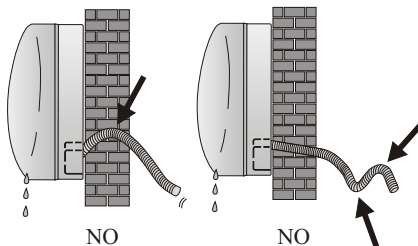

NO

NO

# INSTALLATION MANUAL---Installation of the Indoor unit

## INSTALLATION OF THE INDOOR UNIT

After having connected the pipe according to the instructions, install the connection cables. Now install the drain pipe. After connection, lag the pipe, cables and drain pipe with the insulating material.

1. Arrange the pipes, cables and drain hose well.
2. Lag the pipe joints with insulating material, securing it with vinyl tape.
3. Run the bound pipe, Cables and drain pipe through the wall hole and mount the indoor unit onto the upper part of the mounting plate securely.
4. Press and push the lower part of the indoor unit tightly against the mounting plate.

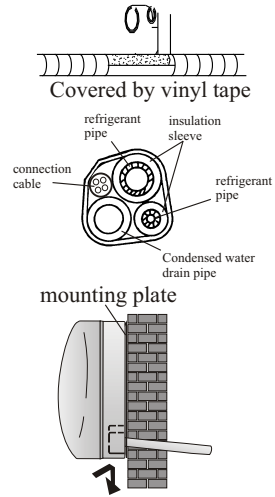

# INSTALLATION MANUAL---Installation of the outdoor unit

- The outdoor unit should be installed on a solid wall and fastened securely.
- The following procedure must be observed before connecting the pipes and connecting cables: decide which is the best position on the wall and leave enough space to be able to carry out maintenance easily.
- Fasten the support to the wall using screw anchors which are particularly suited to the type of wall.
- Use a larger quantity of screw anchors than normally required for the weight they have to bear to avoid vibration during operation and remain fastened in the same position for years without the screws becoming loose.
- The unit must be installed following national regulations.

## Outdoor unit condensed water drainage (only for heat pump models)

The condensed water and the ice formed in the outdoor unit during heating operation can be drained through the drain pipe.

1. Fasten the drain port in the 25mm hole placed in the part of the unit as shown in the picture.
2. Connect the drain port and the drain pipe.  
Make sure that water is drained in a suitable place.

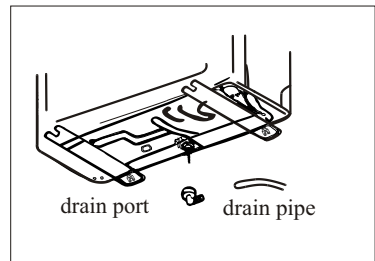

# INSTALLATION MANUAL---Installation of the outdoor unit

## ELECTRICAL CONNECTIONS

1. Remove the handle on the right side plate of outdoor unit.
2. Connect the power connection cord to the terminal board.  
Wiring should fit that of indoor unit.
3. Fix the power connection cord with wire clamp.
4. Confirm if the wire has been fixed properly.
5. An efficient earth connection must be ensured.
6. Recover the handle.

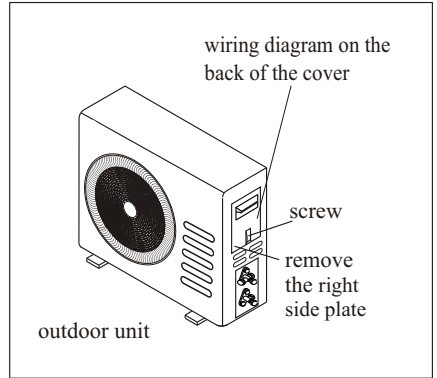

## CONNECTING THE PIPES

Screw the flare nuts to the outdoor unit coupling with the same tightening procedures described for the indoor unit.

To avoid leakage, pay attention to the following points:

1. Tighten the flare nuts using two wrenches. Pay attention not to damage the pipes.
2. If the tightening torque is not sufficient, there will probably be some leakage. With excessive tightening torque there will also be some leakage, as the flange could be damaged.
3. The surest system consists in tightening the connection by using a fix wrench and a torque wrench: in this case use the table on page 24.

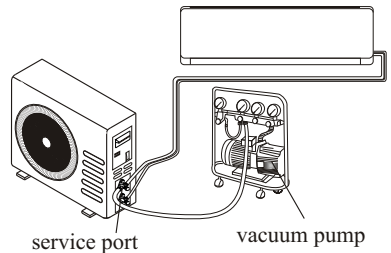
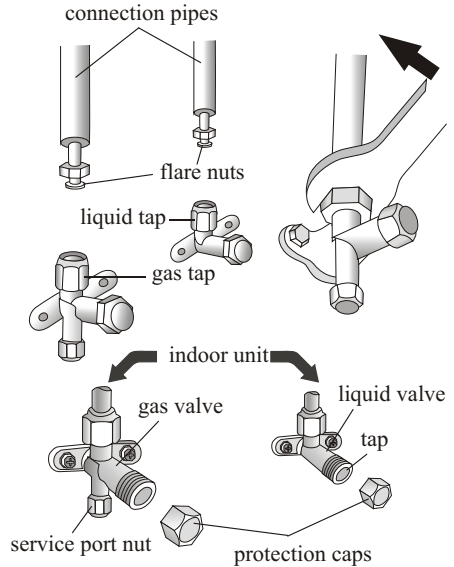



# INSTALLATION MANUAL---Installation of the outdoor unit

## BLEEDING

The air and humidity left inside the refrigerant circulation can cause compressor malfunction. After having connected the indoor and outdoor units, bleed the air and humidity from the refrigerant circulation using a vacuum pump.

- (1) Unscrew and remove the caps from the 2 - way and 3-way valves.
- (2) Unscrew and remove the cap from the service port.
- (3) Connect the vacuum pump hose to the service port.
- (4) Operate the vacuum pump for 10 - 15 minutes until an absolute vacuum of 10 mm Hg has been reached.
- (5) With the vacuum pump still in operation , close the low - pressure knob on the vacuum pump coupling. Stop the vacuum pump.
- (6) Open the 2 - way valve by 1/4 turn and then close it after 10 seconds. Check all the joints for leaks using liquid soap or an electronic leak device.
- (7) Turn the body of the 2-way and 3-way valves. Disconnect the vacuum pump hose.
- (8) Replace and tighten all the caps on the valves.

### 3-way valve diagram

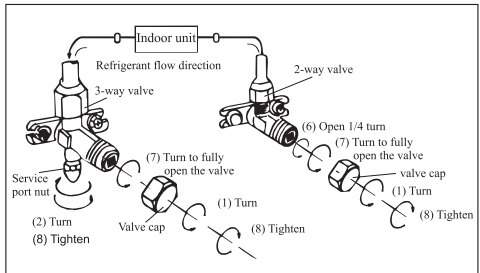
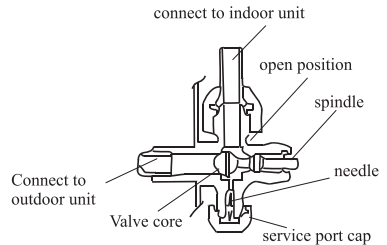

## INSTALLATION MANUAL---operation test

1. Wrap insulating covering around the joints of the indoor unit and fix it with insulating tape.
2. Fix the exceeding part of the signal cable to the piping or to the outdoor unit.
3. Fix the piping to the wall ( after applying insulating tape) using clamps or insert them into plastic slots.
4. Seal the hole in the wall through which the piping is passed so that no air or water can fill.

### Indoor unit test

- Do the ON/OFF and FAN operate correctly?
- Does the MODE operate correctly?
- Do the set point and TIMER function properly?
- Does each lamp light correctly?
- Do the flap for air flow direction operate correctly?
- Is the condensed water drained regularly?

### Outdoor unit test

- Is there any abnormal noise or vibration during operation?
- Could the noise , the air flow or the condensed water drainage disturb the neighbors?
- Is there any coolant leakage?

*Note: the electronic controller allows the compressor to start only three minutes after voltage has reached the system.*

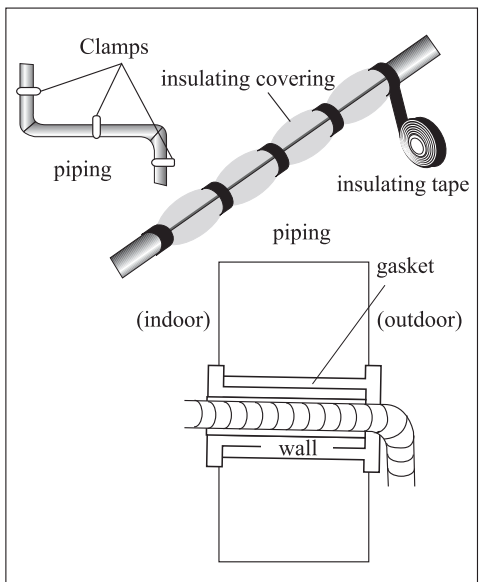

# INSTALLATION MANUAL---Information for the installer

INVERTER TYPE MODEL capacity (Btu/h)	9K	12K	18K	24K	36K
Liquid pipe diameter	1/4 " (φ 6)	1/4 " (φ 6)	1/4 " (φ 6)	1/4 " (φ 6)	3/8 " (φ 9.52)
Gas pipe diameter	3/8 " (φ 9.52)	3/8 " (φ 9.52)	3/8 " (φ 9.52)	1/2 " (φ 12.7)	5/8 " (φ 15.88)
Length of pipe with standard charge	7.5m	7.5m	7.5m	7.5m	7.5m
Maximum distance between indoor and outdoor unit	15m	15m	15m	15m	15m
Additional refrigerant charge	20g/m	20g/m	20g/m	20g/m	30g/m
Max. diff. in level between indoor and outdoor unit	5m	5m	5m	5m	5m
Type of refrigerant(1)	R410A	R410A	R410A	R410A	R410A

(1) Refer to the data rating label stucked on the outdoor unit.

## TIGHTENING TORQUE FOR PROTECTION CAPS AND FLANGE CONNECTION

PIPE	TIGHTENING TORQUE [N x m]	CORRESPONDING STRESS (using a 20 cm wrench)		TIGHTENING TORQUE [N x m]
1/4 " (φ 6)	15 - 20	wrist strength	Service port nut	7 - 9
3/8 " (φ 9.52)	31 - 35	arm strength	Protection caps	25 - 30
1/2 " (φ 12)	35 - 45	arm strength		
5/8 " (φ 15.88)	75 - 80	arm strength		

# INSTALLATION MANUAL---Information for the installer

## WIRING DIAGRAM

For different models, the wiring diagram may be different. Please refer to the wiring diagrams affixed to the indoor unit and outdoor unit respectively.

On the indoor unit, the wiring diagram is located under the front panel;

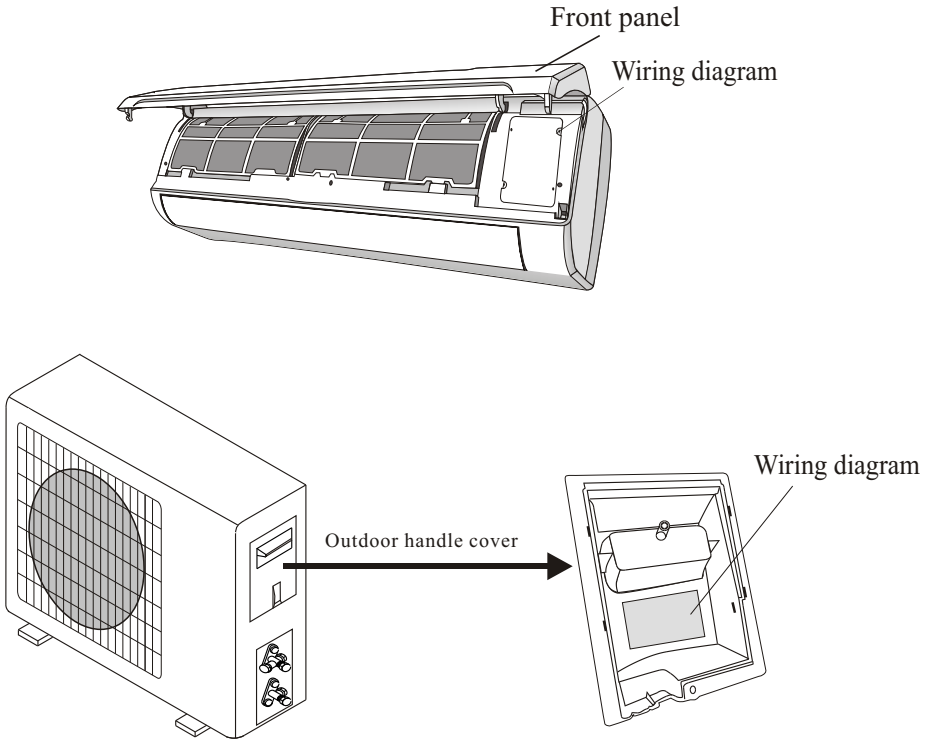

On the outdoor unit, the wiring diagram is located on the backside of the outdoor handle cover.



*Note: For some models will have wires connected to the main PCB of the indoor unit without terminal block.*

# INSTALLATION MANUAL---Information for the installer

## CABLE WIRES SPECIFICATION

INVERTER TYPE MODEL capacity (Btu/h)		9K- 115V	12K- 115V	9K- 230V	12K- 230V	18K	24K	36K
		sectional area						
Power supply cable	N(L2)	3.0mm <sup>2</sup> AWG12	3.0mm <sup>2</sup> AWG12	3.0mm <sup>2</sup> AWG12	3.0mm <sup>2</sup> AWG12	3.0mm <sup>2</sup> AWG12	3.0mm <sup>2</sup> AWG12	3.0mm <sup>2</sup> AWG12
	L(L1)	3.0mm <sup>2</sup> AWG12	3.0mm <sup>2</sup> AWG12	3.0mm <sup>2</sup> AWG12	3.0mm <sup>2</sup> AWG12	3.0mm <sup>2</sup> AWG12	3.0mm <sup>2</sup> AWG12	3.0mm <sup>2</sup> AWG12
		3.0mm <sup>2</sup> AWG12	3.0mm <sup>2</sup> AWG12	3.0mm <sup>2</sup> AWG12	3.0mm <sup>2</sup> AWG12	3.0mm <sup>2</sup> AWG12	3.0mm <sup>2</sup> AWG12	3.0mm <sup>2</sup> AWG12
Connection supply cable	3(L)	AWG 16	AWG 16	AWG 16	AWG 16	AWG 16	AWG 16	AWG 16
	2(N)							
	1(S)							
								

220V 9K , 12K , 18K , 24K , 36K air conditioner indoor unit fuse parameter is 50T, 3.15A,

110V 9K 12K air conditioner indoor unit fuse parameter is 50T, 3.15A,

125V 9K , 12K air conditioner outdoor unit fuse parameter is 61T, 15A,

250V 18K , 22K , 24K air conditioner outdoor unit fuse parameter is 65TS, 25A,

# MAINTENANCE

Periodic maintenance is essential for keeping your air conditioner efficient.

Before carrying out any maintenance, turn the power supply "off" .

## INDOOR UNIT

### ANTIDUST FILTERS

1. Open the front panel (following the direction of the arrow).
2. Keeping the front panel raised with one hand, take out the air filter with the other hand.
3. Clean the filter with water; if the filter is soiled with oil, it can be washed with warm water, not exceeding 113°F (45°C).  
Leave to dry in a cool and dry place.
4. Keeping the front panel raised with one hand, insert the air filter with the other hand.
5. Close front panel.

The electrostatic and the deodorant filter (if installed) cannot be washed and must be replaced with new filters once every 6 months.

### CLEANING THE HEAT EXCHANGER

1. Open the front panel of the unit and remove by lifting up and unhooking it from the hinges to make the cleaning easier.
2. Clean the indoor unit using a cloth with water not higher than 104°F (40°C) and neutral soap.  
Never use aggressive solvents or detergents.
3. If the battery of the outdoor unit is clogged, remove any leaves or waste by hand and remove the dust with an air jet or a bit of water.

### END OF SEASON MAINTENANCE

1. Disconnect the automatic switch or the plug.
2. Clean and replace the filters.
3. On a sunny day let the air conditioner work on ventilation for several hours , so that the inside of the unit can dry completely.

### REPLACING THE BATTERIES

When:

- There is no confirmation beep from the indoor unit.
- The LCD doesn't activate.

How:

- Remove back cover plate.
- Place the new batteries respecting the symbols + and - .

N.B: Use only new batteries. Remove the batteries from the remote control when the air conditioner is not in operation.

**WARNING !** Do not throw batteries into common trash, they should be disposed of in the special containers situated in collection points.

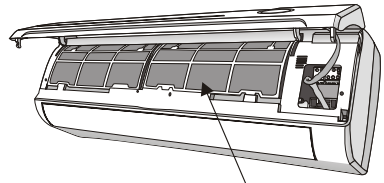
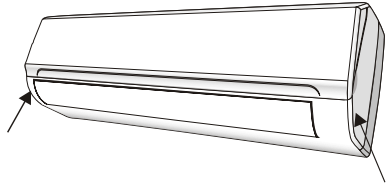

Anti-dust filter

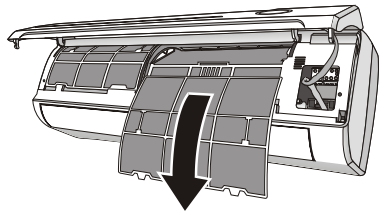

# TROUBLESHOOTING

MALFUNCTION	POSSIBLE CAUSES
The appliance does not operate	Power failure/plug pulled out.
	Damaged indoor/outdoor unit fan motor.
	Faulty compressor thermomagnetic circuit breaker.
	Faulty protective device or fuses.
	Loose connections or plug pulled out.
	It sometimes stops operating to protect the appliance.
	Voltage higher or lower than the voltage range.
	Active TIMER-ON function.
Strange odor	Dirty air filter.
Noise of running water	Back flow of liquid in the refrigerant circulation.
A fine mist comes from the air outlet	This occurs when the air in the room becomes very cold, for example in the “COOLING” or “DEHUMIDIFYING/DRY” modes.
A strange noise can be heard	This noise is made by the expansion or contraction of the front panel due to variations in temperature and does not indicate a problem.
Insufficient airflow, either hot or cold	Unsuitable temperature setting.
	Obstructed air conditioner intakes and outlets.
	Dirty air filter.
	Fan speed set at minimum.
	Other sources of heat in the room.
The appliance does not respond to commands	No refrigerant.
	Remote control is not close enough to indoor unit.
	The batteries of remote control need to be replaced.
The display is off	Obstacles between remote control and signal receiver in indoor unit.
	Active LIGHT function.
Switch off the air conditioner immediately and cut off the power supply in the event of:	Power failure.
	Strange noises during operation.
	Faulty electronic control board.
	Faulty fuses or switches.
	Spraying water or objects inside the appliance.
	Overheated cables or plugs.
	Very strong smells coming from the appliance.

## ERROR SIGNALS ON THE DISPLAY

In case of error, the display on the indoor unit shown the following error codes:

Display	Description of the trouble	Display	Description of the trouble
E1	Indoor temperature sensor fault	E9	Outdoor IPM module fault
E2	Indoor pipe temperature sensor fault	EA	Outdoor current detect fault
E3	Outdoor pipe temperature sensor fault	EE	Outdoor PCB EEPROM fault
E4	Refrigerant system leakage or fault	EF	Outdoor fan motor fault
E5	Malfunction of indoor fan motor	EH	Outdoor suction temperature sensor fault
E7	Outdoor air temperature sensor fault		
E8	Outdoor discharge temperature sensor fault		